

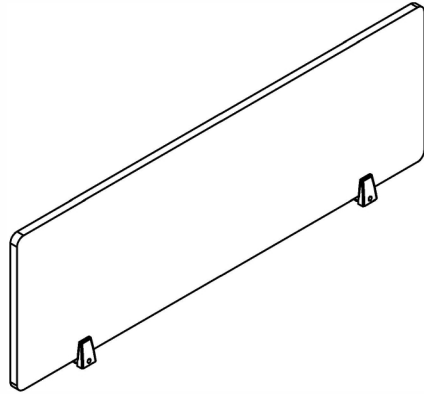









## DIVIDER MOUNTING ASSEMBLY INSTRUCTIONS



PARTS LIST							
Part	HB	HB	HB	HB	HB	HB	HB
Qty.							
Item							
Pinch clamps (2 PACK) 	2	2	1	4	4	4	-
C brackets (2 PACK) 	-	-	-	-	4	-	2

Please remove red Hardware Bag from box.  
Parts with "HB" are in red Hardware Bag.

### Notes:

- Hardware works with both Fabric and Acrylic Dividers
- Rubber Gaskets to be used with Acrylic Dividers only
- Offset Adapter to be used when mounting a Surface Mounted Divider adjacent to Monitor Arms or Surface Mounted Power Modules.

