



STAXX™

MONITOR ARMS



HAT
COLLECTIVE™
HUMAN ACTIVE TECHNOLOGY

MODULAR FLEXIBILITY.

Designed for modularity, this groundbreaking display system can accommodate up to six monitors using a single mount. Staxx™ is a completely configurable pole-based solution allowing the addition of monitors by stacking more of the same parts on top of each other.

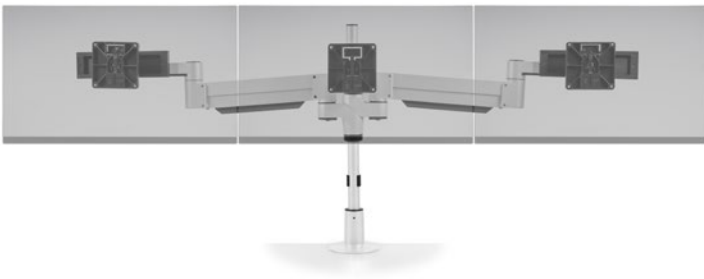



FEATURES

- **Scalable:** Easy to install and reconfigure.
- **Capable:** Mount large screens stacked or side by side.
- **Customizable:** Available in a wide range of sizes and configurations.
- **Adjustable:** Flexible extension arms provide easy positioning and personalized viewing angles.
- **Sliders:** Allows the user to fine tune monitor positioning and achieve their ideal viewing angle when utilizing 2 or more monitors (available in four configurations).

SPECIFICATIONS

Finishes

	Flat White 248
	Silver 124
	Vista Black 104

Mount: C-Clamp, Grommet

Compatibility:
Up to 1.5" desk thickness

Mount Conversion Kits

8524-FM-CK: Flexmount Conversion Kit
8524-TM-CK: Thru-Desk Conversion Kit

See pages 3-5 for additional specs

WARRANTY

10 Years

STAXX™ STANDARD



STAXX SINGLE

Screen Size: Up to 50"

Weight Capacity:

Flat Monitor: Up to 30 lbs.
Curved Monitor: Up to 22 lbs.

Part Number: STX-01S-___



STAXX ONE OVER ONE

Screen Size: Up to 30"

Weight Capacity: Up to 20 lbs. per monitor

Part Number: STX-11S-___

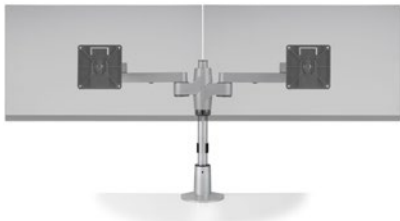

STAXX DUAL

Screen Size: Up to 24"

Weight Capacity: Up to 20 lbs. per monitor

Part Number: STX-02S-___

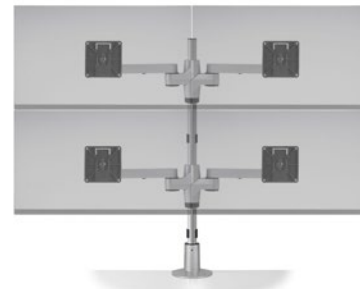

STAXX TWO OVER TWO

Screen Size: Up to 24"

Weight Capacity: Up to 15 lbs. per monitor

Part Number: STX-22S-___

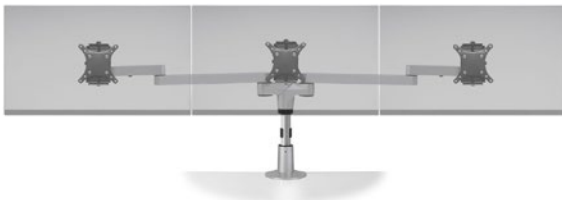

STAXX TRIPLE

Screen Size: Up to 24"

Weight Capacity: Up to 15 lbs. per monitor

Part Number: STX-03S-___

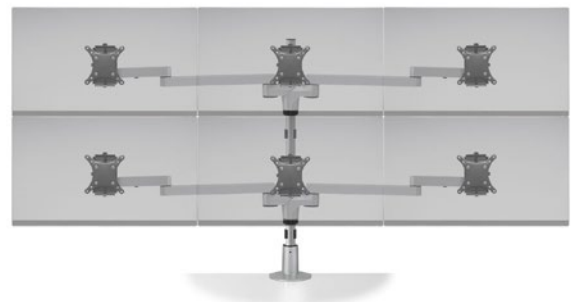

STAXX THREE OVER THREE

Screen Size: Up to 24"

Weight Capacity: Up to 10 lbs. per monitor

Part Number: STX-33S-___



STAXX WIDE

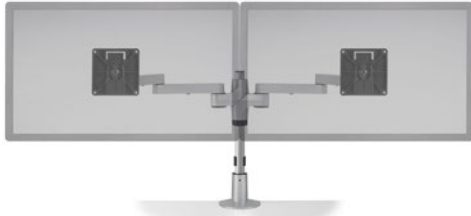

STAXX DUAL WIDE

Screen Size: 24" - 30"

Weight Capacity: Up to 20 lbs. per monitor

Part Number: STX-02W-___



STAXX TWO OVER TWO WIDE

Screen Size: 24" - 30"

Weight Capacity: Up to 15 lbs. per monitor

Part Number: STX-22W-___

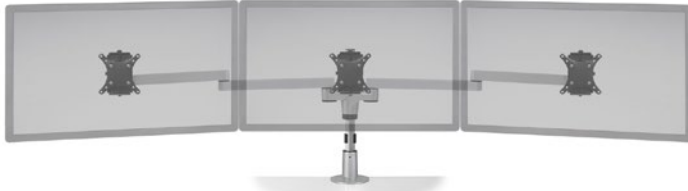

STAXX TRIPLE WIDE

Screen Size: 24" - 30"

Weight Capacity: Up to 15 lbs. per monitor

Part Number: STX-03W-___

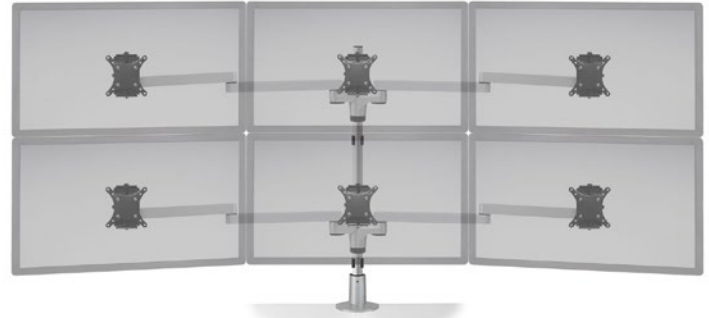

STAXX THREE OVER THREE WIDE

Screen Size: 24" - 30"

Weight Capacity: Up to 10 lbs. per monitor

Part Number: STX-33W-___

STAXX ARTICULATING



STAXX DUAL ARTICULATING

Screen Size: Up to 27"

Weight Capacity:

- 10 - 23 lbs. per monitor, STX-450-___
- 3 - 10 lbs. per monitor, STX-500-___
- 7 - 17 lbs. per monitor, STX-600-___
- 10 - 22 lbs. per monitor, STX-800-___
- 13 - 28 lbs. per monitor, STX-1000-___



STAXX DUAL ARTICULATING w/LAPTOP HOLDER

Screen Size: Up to 27"

Weight Capacity:

- Monitor:
- 10 - 23 lbs. per monitor, STX-450-___
 - 3 - 10 lbs. per monitor, STX-500-___
 - 7 - 17 lbs. per monitor, STX-600-___
 - 10 - 22 lbs. per monitor, STX-800-___
 - 13 - 28 lbs. per monitor, STX-1000-___

- Laptop:
- 3 - 13.5 lbs., all sku's

STAXX WITH SLIDERS



STAXX DUAL WITH SLIDERS

Screen Size: Up to 27" per monitor

Weight Capacity: Up to 20 lbs. per monitor

Part Number: STX-02-SLD-___

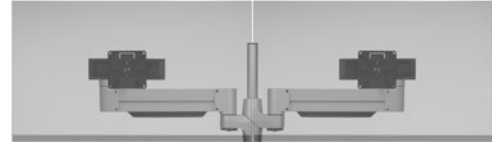

STAXX DUAL ARTICULATING WITH SLIDERS

Screen Size: Up to 27" per monitor

Weight Capacity:

3 - 10 lbs. per monitor, STX-2-500-SLD-___

10 - 22 lbs. per monitor, STX-2-800-SLD-___

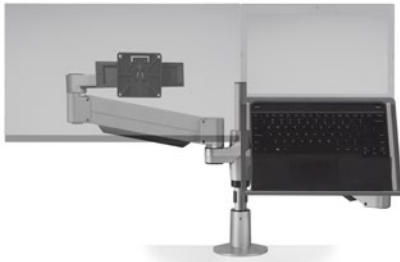

STAXX DUAL ARTICULATING w/LAPTOP HOLDER AND SLIDER

Screen Size: Up to 27" per monitor

Weight Capacity:

Monitor:

3 - 10 lbs. per monitor, STX-2-500-8510-SLD-___

10 - 22 lbs. per monitor, STX-2-800-8510-SLD-___

Laptop:

3 - 13.5 lbs.

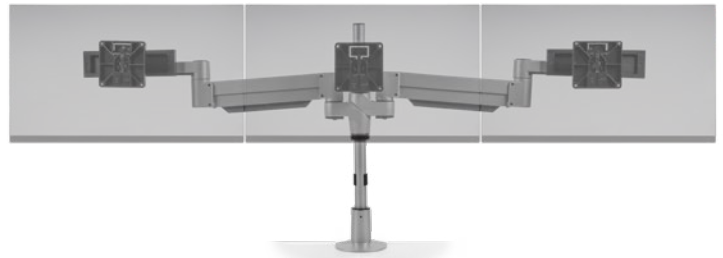

STAXX TRIPLE ARTICULATING WITH SLIDERS

Screen Size: Up to 27" per monitor

Weight Capacity: Up to 20 lbs. per monitor

Weight Capacity:

3 - 10 lbs. per monitor, STX-3S-500-SLD-___

10 - 22 lbs. per monitor, STX-3S-800-SLD-___

